

SBI PO Prelims 2020-2021 (Memory Based Paper) – 5th January 2021 (Solutions)

S1. Ans.(b)

Sol. “C-F” combination is grammatically incorrect as ‘making’ should be used in place of ‘made’

A-E: The regulator did not wait for sufficient safety and efficacy data to be collected and did not share information about the clinical trials before granting approval.

B-D: If there is already some degree of apprehension about the safety and efficacy of COVID-19 vaccines, the opaque nature of the approval process has done little to mitigate such concerns.

S2. Ans.(e)

Sol. Both B-E & C-D are correct.

B-E: More than being a scientific methodology, clinical trials are a method of human cooperation.

C-D: The coercive attempt to falsify a study participant’s claims and intimidate him or her violates the agreed upon rules of clinical trials

S3. Ans.(b)

Sol. Option (b) is the correct choice.

Distribute, dispense and disburse are similar in meaning, therefore, disburses & distributes can replace dispenses.

Disburse: To distribute

Dispense: to give or provide people with something

Squander: to waste time, money, etc.

S4. Ans.(c)

Sol. Option (c) is the correct choice. The use of ‘tools’ will be incorrect grammatically while both system and method can replace mechanism. Therefore, option (c) is the correct choice.

Mechanism: the way in which something works or is done

System: a group of things or parts that work together

Method: a way of doing something

S5. Ans.(a)

Sol. Option (a) is the correct choice because none of the options can replace ‘qualify’ to make a meaningful and contextually correct statement.

Hamper: to make something difficult

Inclined: wanting to behave in a particular way

S6. Ans.(c)

Sol. Option (c) is the correct choice. The use of “relevant” is grammatically incorrect.

Disruption: the action of preventing something, especially a system, process, or event, from continuing as usual or as expected:

Obstruction: the act of stopping something from happening or moving

Disturbance: something that makes you stop what you are doing

S7. Ans.(b)

Sol. Option (b) is the correct choice. All the other options are either making sentence grammatically or contextually incorrect.

Meaning of some other words:

Nabbed: to catch or arrest somebody who is doing something wrong

Snatched: to attempt to seize something suddenly

Persist: to continue doing something even though other people say that you are wrong or that you cannot do it

Apprehend: arrest, seize apprehend a thief.

Endured: to suffer something painful or uncomfortable, usually without complaining

Sustain: to keep somebody/something alive or healthy

S8. Ans.(c)

Sol. Option (c) is the correct choice. All the other options are either making sentence grammatically or contextually incorrect.

Meaning of some other words:

Drenched: to make somebody/something completely wet

Affected: make somebody/something change in a particular way; to influence somebody/something

Rejuvenate: to make somebody/something feel or look younger

Drenched: to make somebody/something completely wet

Devoured: to eat something quickly because you are very hungry

Swayed: to influence somebody

S9. Ans.(d)

Sol. Option (d) is the correct choice. All the other options are either making sentence grammatically or contextually incorrect.

Meaning of some other words:

Assess: to determine the importance, size, or value of

Evaluate: to study the facts and then form an opinion about something

Enhance: heighten, increase especially

Analyze: to look at or think about the different parts or details of something carefully in order to understand or explain it

S10. Ans.(d)

Sol. Option (d) is the correct. We need to replace ‘thoroughly’ with thorough because thoroughly is an adverb while we need an adjective (thorough) to tell us more about the noun (Knowledge).

S11. Ans.(b)

Sol. Option (b) is the correct choice.

Use 'found guilty of' in place of 'found guilty for'.

Ex- Guilty of murder

Guilty of theft.

S12. Ans.(d)

Sol. Option (d) is the correct choice for the given question.

Replace "not entrusted with" with "not be entrusted with" because 'should' is used before 'not' and we use V1 after 'should' in active voice and be+V3 in passive voice.

S13. Ans.(a)

Sol. The correct sequence is **CDAB**.

The correct statement after rearrangement:

The MNM's promise to directly pay women a monthly amount may be **viewed (C)** as a **strategy (D)** to grab attention in an over-crowded, highly **competitive (A)** electoral **landscape (B)**.

S14. Ans.(d)

Sol. Option (d) is the correct choice.

The correct sequence is **BDAC**.

The correct statement after rearrangement:

With the Indian economy gradually **finding (B)** its feet after a historic contraction, economic commentators have **busied (D)** themselves with **debating (A)** the need for fiscal expansion and the **viability(C)** of a "V-shaped recovery".

S15. Ans.(d)

Sol. Option (d) is the correct choice because in the 2nd paragraph of the passage it is mentioned that "the tide is turning. Increasing awareness around these issues has led to a rise in what is known as conscious consumption, a movement of people who seek out ways to make positive decisions about what to buy and look for a solution to the negative impact consumerism is having on our world."

Q16. Which of the following statement(s) is/are corroborating the statement made by the author that "the tide is turning"?

(i) 74% of those surveyed would pay an extra 5% for their clothes if there was a guarantee that workers were paid fairly

(ii) Awareness about environmentally conscious manufacturing processes among customers while making their choices is increasing.

(iii) Every time we spend our cash, we are making an active choice about the companies we support and the practices we endorse.

(a) Both (i) & (ii)

(b) Both (i) & (iii)

(c) Only (iii)

(d) Only (i)

(e) None of these

S16. Ans.(a)

Sol. Option (a) is correct because both (i) & (ii) are correct. Both these statements indicate conscious consumption and show that the tide has turned (that people's opinion or a situation is changing) (iii) is incorrect and does not show any changing behaviour and is just making a general statement.

Q17. Which of the following statement is true in context of the passage?

- (a) The biggest problem with consumerism is the fact that people do not realize that there is a problem.
- (b) Difficulty in making an informed choice is increasingly important for the conscious consumer.
- (c) We are currently consuming resources at an unsustainable rate, which is causing mass environmental destruction and social problems across the world.
- (d) Conscious consumption can help in taking significant number of people out of poverty.
- (e) None of these

S17. Ans.(d)

Sol. Option (d) is correct. All the other statements are incorrect (or not mentioned or implied) in context of the passage.

Refer to the 3rd paragraph of the passage, "74% of those surveyed would pay an extra 5% for their clothesIf you're thinking that 5% doesn't sound like a lot, consider the fact that the fashion industry could take a staggering 125 million people out of poverty by adding only 1% of its profits to workers' wages"

S18. Ans.(a)

Sol. Option (a) is the correct choice.

Refer to the last paragraph of the passage, " I believe technology is the key to dealing with the challenges created by consumerism. Open data, social networks and mobile tech can change the game. Groundbreaking technologies could enable transparency in supply chains" . Information about supply chains, about materials and processes can give add to the conscious movement.

S19. Ans.(b)

Sol. Endorse means to promote the interests or cause of. Hence, promote is the word most similar in meaning.

Censure: to tell somebody, in a strong and formal way, that he/she has done something wrong

Veto: A veto (Latin for "I forbid") is the power (used by an officer of the state, for example) to unilaterally stop an official action, especially the enactment of legislation

Sabotage: a deliberate action aimed at weakening a polity, effort, or organization through subversion, obstruction, disruption, or destruction.

S20. Ans.(e)

Sol. Option (e) is the correct choice.

Staggering means that you find difficult to believe. Hence, confound which means to confuse and surprise somebody is the word most similar in meaning.

Enfeebling: unsympathetic, harsh, or callous.

Mundane: ordinary; not interesting or exciting

S21. Ans.(e)

Sol. Option (e) is the correct choice. All the other options are either grammatically or contextually incorrect.

Embarked: to go onto a journey.

Persist: to continue doing something even though other people say that you are wrong or that you cannot do it

Ceased: to stop or end

Sustaining: to keep somebody/something alive or healthy

S22. Ans.(b)

Sol. The correct sequence is **FDEACB**.

F is the 1st statement because it is stating the announcement on which the whole discussion is based.

D is the 2nd statement because it is then elaborating the rules mentioned in **F**

E-A are the next two statements because they are then giving the reason due to which the rules were announce.

C is the penultimate statement because it is stating how these fixes are short term and therefore in the final statement, we can expect a long-term solution.

B Since in **C** short term fixes are mentioned, **B** then concludes the paragraph by giving a solution which could be long term.

S23. Ans.(a)

Sol. The correct sequence is **FDEACB**.

F is the 1st statement because it is stating the announcement on which the whole discussion is based.

D is the 2nd statement because it is then elaborating the rules mentioned in **F**

E-A are the next two statements because they are then giving the reason due to which the rules were announce.

C is the penultimate statement because it is stating how these fixes are short term and therefore in the final statement, we can expect a long-term solution.

B Since in **C** short term fixes are mentioned, **B** then concludes the paragraph by giving a solution which could be long term.

S24. Ans.(c)

Sol. The correct sequence is **FDEACB**.

F is the 1st statement because it is stating the announcement on which the whole discussion is based.

D is the 2nd statement because it is then elaborating the rules mentioned in **F**

E-A are the next two statements because they are then giving the reason due to which the rules were announce.

C is the penultimate statement because it is stating how these fixes are short term and therefore in the final statement, we can expect a long-term solution.

B Since in **C** short term fixes are mentioned, **B** then concludes the paragraph by giving a solution which could be long term.

S25. Ans.(d)

Sol. The correct sequence is **FDEACB**.

F is the 1st statement because it is stating the announcement on which the whole discussion is based.

D is the 2nd statement because it is then elaborating the rules mentioned in **F**

E-A are the next two statements because they are then giving the reason due to which the rules were announce.

C is the penultimate statement because it is stating how these fixes are short term and therefore in the final statement, we can expect a long-term solution.

B Since in **C** short term fixes are mentioned, **B** then concludes the paragraph by giving a solution which could be long term.

S26. Ans.(a)

Sol. The correct sequence is **FDEACB**.

F is the 1st statement because it is stating the announcement on which the whole discussion is based.

D is the 2nd statement because it is then elaborating the rules mentioned in **F**

E-A are the next two statements because they are then giving the reason due to which the rules were announce.

C is the penultimate statement because it is stating how these fixes are short term and therefore in the final statement, we can expect a long-term solution.

B Since in **C** short term fixes are mentioned, **B** then concludes the paragraph by giving a solution which could be long term.

S27. Ans.(c)

Sol. Option (c) is incorrect.

In (c) replace 'the' with 'than' because after 'No sooner' we use 'than'.

S28. Ans.(a)

Sol. Option (a) is incorrect because in place of 'which' we should use 'that' because after 'the same' we use 'that' when the verb is clear.

S29. Ans.(d)

Sol. There is an error in option (d), we will use 'skilfully' in place of 'skilful' as it describes the specialty of the verb 'decorated'

S30. Ans.(e)

Sol. All the given statements are correct.

S31. Ans.(a)

$$\text{Sol. Total unsold CD's by A \& D} = 600 \times \frac{25}{100} \times \frac{80}{100} + 600 \times \frac{20}{100} \times \frac{75}{100}$$

$$= 120 + 90$$

$$= 210$$

$$\text{Total sold CD's by C} = 600 \times \frac{40}{100} \times \frac{35}{100} = 84$$

$$\text{Required difference} = 210 - 84 = 126$$

S32. Ans.(e)

$$\text{Sol. Total CD's sold by E} = 600 \times \frac{15}{100} \times \frac{40}{100} \times \frac{225}{100} = 81$$

$$\text{Total CD's ordered by E} = 81 \times \frac{100}{27} = 300$$

$$\text{Total CD's ordered by C} = 600 \times \frac{40}{100} = 240$$

$$\text{Required percentage} = \frac{300-240}{240} \times 100 = 25\%$$

S33. Ans.(b)

Sol. Total unsold CD's by B, C & D

$$= 600 \times \frac{15}{100} \times \frac{60}{100} + 600 \times \frac{40}{100} \times \frac{65}{100} + 600 \times \frac{20}{100} \times \frac{75}{100}$$

$$= 54 + 156 + 90 = 300$$

$$\text{Required average} = \frac{300}{3} = 100$$

S34. Ans.(a)

$$\text{Sol. Total CD's sold by A \& D} = 600 \times \frac{25}{100} \times \frac{20}{100} + 600 \times \frac{20}{100} \times \frac{25}{100}$$

$$= 30 + 30 = 60$$

$$\text{Total CD's sold by B} = 600 \times \frac{15}{100} \times \frac{40}{100} = 36$$

$$\text{Required ratio} = 60 : 36 = 5 : 3$$

S35. Ans.(a)

$$\text{Sol. Total CD's ordered by shopkeeper X} = 600 \times \frac{20}{100} \times \frac{75}{100} \times \frac{200}{100} = 180$$

$$\text{Unsold CD's by X} = 180 \times \frac{70}{100} = 126$$

$$\text{Unsold CD's by A} = 600 \times \frac{25}{100} \times \frac{80}{100} = 120$$

$$\text{Required parentage} = \frac{126-120}{120} \times 100 = 5\%$$

S36. Ans.(e)

Sol. (i) $x^2 - 7x + 10 = 0$

$x^2 - 2x - 5x + 10 = 0$

$(x - 2)(x - 5) = 0$

$x = 2, 5$

(ii) $y^2 - 2y - 3 = 0$

$y^2 + y - 3y - 3 = 0$

$(y + 1)(y - 3) = 0$

$y = -1, 3$

∴ *no relation*

S37. Ans.(c)

Sol. (i) $x^2 - 24x + 143 = 0$

$x^2 - 11x - 13x + 143 = 0$

$(x - 11)(x - 13) = 0$

$x = 11, 13$

(ii) $y^2 - 29y + 210 = 0$

$y^2 - 14y - 15y + 210 = 0$

$(y - 14)(y - 15) = 0$

$y = 14, 15$

∴ $y > x$

S38. Ans.(e)

Sol. (i) $x^2 + 22x + 117 = 0$

$x^2 + 9x + 13x + 117 = 0$

$(x + 9)(x + 13) = 0$

$x = -9, -13$

(ii) $y^2 + 23y + 132 = 0$

$y^2 + 11y + 12y + 132 = 0$

$(y + 11)(y + 12) = 0$

$y = -11, -12$

∴ *no relation*

S39. Ans.(b)

Sol. (i) $2x^2 - 3x - 20 = 0$

$2x^2 - 8x + 5x - 20 = 0$

$2x(x - 4) + 5(x - 4) = 0$

$(x - 4)(2x + 5) = 0$

$x = 4, -5/2$

(ii) $2y^2 + 11y + 15 = 0$

$2y^2 + 6y + 5y + 15 = 0$

$2y(y + 3) + 5(y + 3) = 0$

$(2y + 5)(y + 3) = 0$

$y = -\frac{5}{2}, -3$

$x \geq y$

S40. Ans.(d)

Sol. (i) $x^2 - 12x + 32 = 0$

$$x^2 - 8x - 4x + 32 = 0$$

$$x(x - 8) - 4(x - 8) = 0$$

$$(x - 8)(x - 4) = 0$$

$$x = 8, 4$$

(ii) $y^2 - 20y + 96 = 0$

$$y^2 - 12y - 8y + 96 = 0$$

$$y(y - 12) - 8(y - 12) = 0$$

$$(y - 8)(y - 12) = 0$$

$$y = 8, 12$$

$$y \geq x$$

S41. Ans.(c)

Sol. Let speed of current be x km/hr.

ATQ,

$$(240 - x) \times \frac{60}{100} = x$$

$$144 - 0.6x = x$$

$$1.6x = 144$$

$$x = 90$$

$$\text{speed in upstream} = 240 - 90 = 150 \text{ km/hr}$$

S42. Ans.(a)

Sol. ATQ,

$$[2X(1.08)^2 - 2X] - \frac{X \times 15 \times 2}{100} = 820$$

$$[2.3328X - 2X] - \frac{3X}{10} = 820$$

$$\Rightarrow \frac{3328X}{10000} - \frac{3X}{10} = 820$$

$$\Rightarrow \frac{328X}{10000} = 820$$

$$X = 25000 \text{ Rs.}$$

S43. Ans.(b)

Sol. Speed of train A = $\frac{400}{16} = 25$ m/sec

So, speed of train B = 25 m/sec

ATQ,

$$\frac{400 + x}{25} = 24$$

$$x = 200 \text{ m}$$

Now time required to cross platform by B

$$= \frac{400 + 200 + 400}{25} = 40 \text{ sec}$$

S44. Ans.(d)**Sol.** Ratio of efficiency of A and B = 3 : 5

⇒ Time taken by A and B alone to complete the work = 5 : 3

Ratio of time taken by B and C alone to complete the work = 4 : 5

⇒ Ratio of time taken by A, B and C alone to complete the work = 20 : 12 : 15

Let, A, B and C alone can complete the work alone in 20x, 12x and 15x days respectively.

ATQ,

$$\frac{12}{20x} + \frac{12}{12x} = \frac{80}{100}$$

$$\Rightarrow \frac{144+240}{240x} = \frac{4}{5}$$

$$\Rightarrow \frac{5 \times 384}{4 \times 240} = x$$

$$\Rightarrow x = 2$$

Let in 'a' days 'B' and 'C' can complete 60% of work

ATQ,

$$\frac{a}{12 \times 2} + \frac{a}{15 \times 2} = \frac{60}{100}$$

$$\Rightarrow \frac{5a+4a}{120} = \frac{3}{5}$$

$$\Rightarrow a = \frac{3}{5} \times \frac{120}{9} = 8 \text{ days}$$

S45. Ans.(d)**Sol.** Let side of square be a cm.

$$\therefore a^2 = 400 \text{ cm}^2$$

$$a = 20 \text{ cm}$$

$$\text{Length of rectangle } (\ell) = 20 \times 1.4 = 28 \text{ cm}$$

ATQ,

$$4 \times 20 = 2(\ell + b) \quad [b \rightarrow \text{breadth of rectangle}]$$

$$80 = 2(28 + b)$$

$$b = 12 \text{ cm}$$

$$\therefore \text{Area of rectangle} = 28 \times 12 = 336 \text{ cm}^2$$

S46. Ans.(b)**Sol.** Let cost price of shirt = 100x

So, cost price of jeans = 132.5x

$$\text{New cost price of jeans} = 132.5x \times 1.3 = 172.25x$$

$$\text{Selling price of jeans} = 172.25x \times 1.25 = 215.3125x$$

$$\text{Cost price of jeans} = 4134 \times \frac{132.5x}{215.3125x}$$

$$= 2544 \text{ Rs.}$$

$$\text{Cost price of shirt} = 2544 \times \frac{100x}{132.5x} = 1920 \text{ Rs.}$$

$$\text{Marked price of shirt} = 1920 \times \frac{115}{100} = 2208 \text{ Rs.}$$

Alternate

Let cost price of jeans = $53x$

So, cost price of shirt = $40x$

New cost price of jeans = $53x \times 1.3 = 68.9x$

Selling price of jeans = $68.9x \times 1.25$

So, $4134 = 68.9x \times 1.25$

$x = 48$

Cost price of shirt = $40 \times 48 = 1920 \text{ Rs.}$

Marked price of shirt = $1920 \times \frac{115}{100} = 2208 \text{ Rs}$

S47. Ans.(c)

Sol. Let quantity of water in first mixture be x liters

Then quantity of milk in the first mixture = $(x+6)$ lit

Quantity of water added = 15 ltr

And quantity of milk added = 25 lit

ATQ

$$\frac{x+15}{x+6+25} = \frac{9}{13}$$

$$\Rightarrow x=21$$

Total quantity of water in final mixture = 36 ltrs.

S48. Ans.(d)

Sol. Let total profit = $100x$

A get 20% of total profit for managing business = $20x$

Remaining profit is shared in the ratio of their profit sharing

= $8000 \times 5 : 10,000 \times 12$

= 1 : 3

Remaining profit is divided between A and B in the ratio 1 : 3.

$$\Rightarrow \text{A's total profit} = 20x + 80x \times \frac{1}{4}$$

$$= 20x + 20x$$

$$= 40x$$

ATQ,

$$40x = 2500$$

$$\Rightarrow \text{Total profit} = 100x = \frac{2500}{40} \times 100$$

$$= 6250$$

S49. Ans.(a)

Sol. Let salary of man be Rs. 100 (%)

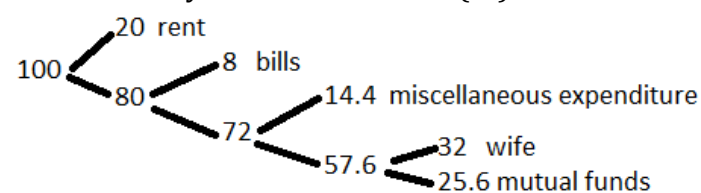

$$\text{Amount spent on rent} = \frac{20}{100} \times 50000 = \text{Rs. } 10000$$

$$\text{Amount invested in mutual funds} = \frac{25.6}{100} \times 50000 = \text{Rs. } 12800$$

$$\text{Required difference} = 12800 - 10000 = 2800 \text{ Rs}$$

S50. Ans.(b)

Sol. In this case we need to select the probability of choosing one bag out of two given bags which will be $\frac{1}{2}$

So, the required probability = $\frac{1}{2}$ (Red ball from bag 1 + Red ball from bag 2)

$$= \frac{1}{2} \left(\frac{7}{14} + \frac{5}{14} \right)$$

$$= \frac{12}{28} = \frac{6}{14} = \frac{3}{7}$$

S51. Ans.(e)

Sol. Total female visitors on Sunday = $120 \times \frac{76}{24} = 380$

Total female visitors on Monday = $280 \times \frac{30}{70} = 120$

Total female visitors on Tuesday = $500 \times \frac{37.5}{62.5} = 500 \times \frac{3}{5} = 300$

Total female visitors on Wednesday = $420 \times \frac{40}{60} = 280$

Required difference = $300 + 280 - 380 - 120 = 580 - 500 = 80$

S52. Ans.(c)

Sol. Total visitors on Wednesday = $420 \times \frac{100}{60} = 700$

Total number of visitors on Sunday = $120 \times \frac{100}{24} = 500$

Required percentage = $\frac{70-50}{50} \times 100 = 40\%$

S53. Ans.(a)

Sol. Total number of male visitors on Friday = $\frac{125}{100} \times 280 = 350$

Total number of female visitors on Friday = $\frac{140}{100} \times 500 \times \frac{100}{62.5} = 1120$

Total visitors on Friday = $1120 + 350 = 1470$

S54. Ans.(b)

Sol. Total number of visitors on Wednesday = $420 \times \frac{100}{60} = 700$

Total number of female visitors on Sunday and Monday = $120 \times \frac{76}{24} + 280 \times \frac{30}{70}$
 $= 380 + 120 = 500$

Required difference = $700 - 500 = 200$

S55. Ans.(b)

Sol. Total number of visitors on all four days = $120 \times \frac{100}{24} + 280 \times \frac{100}{70} + 500 \times \frac{100}{62.5} + 420 \times \frac{100}{60}$
 $= 500 + 400 + 800 + 700 = 2400$

Total **number** of guides required = $\frac{2400}{5} = 480$

S56. Ans.(e)**Sol.** Wrong number = 158

Pattern of series -

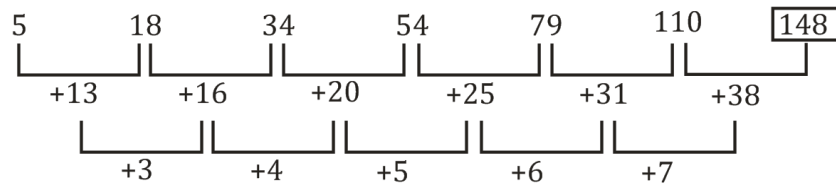

So, there should be 148 in the place of 158

S57. Ans.(c)**Sol.** Wrong number = 134

Pattern of series -

$112 + 16 = 128$

$128 - 20 = 108$

$108 + 24 = 132$

$132 - 28 = 104$

$104 + 32 = 136$

$136 - 36 = 100$

So, should be 136 come in the place of 134.

S58. Ans.(d)**Sol.** Wrong number = 920

Pattern of series -

$5 \times 1 + 1 = 6$

$6 \times 2 + 2 = 14$

$14 \times 3 + 3 = 45$

$45 \times 4 + 4 = 184$

$184 \times 5 + 5 = 925$

$925 \times 6 + 6 = 5556$

So, 925 should come in the place of 920.

S59. Ans.(a)

Wrong number = 92

Pattern of series -

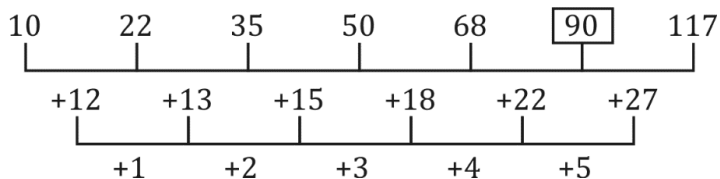

So, 90 should come in the place of 92.

S60. Ans.(b)**Sol.**

$$\begin{array}{cccccc}
 64 & 34 & 36 & 56 & 114 & 287 & \boxed{863} \\
 \times 0.5+2 & \times 1+2 & \times 1.5+2 & \times 2+2 & \times 2.5+2 & \times 3+2 &
 \end{array}$$

Wrong number is 860.

Solutions (61–65):

Let total students in A = a

And, total students in B = b

$$\text{Total students in Commerce in A} = a \times \frac{75}{4} \times \frac{1}{100} = \frac{3a}{16}$$

$$\text{Total students in Science in B} = b \times \frac{200}{7} \times \frac{1}{100} = \frac{2b}{7}$$

$$\text{Given, } \frac{3a}{16} + \frac{2b}{7} = 105 \text{ ----- (i)}$$

$$\text{And } a + b = 450 \text{ -----(ii)}$$

So, from (i) and (ii),

$$\text{Total students in A} = 240$$

$$\text{Total students in B} = 210$$

$$\text{Total students in Commerce in B} = \frac{400}{21} \times \frac{1}{100} \times 210 = 40$$

$$\text{Total students in Art in A} = \frac{1}{2} \times 240 = 120$$

$$\text{Now, total students in Science in A} = 240 - \frac{3}{16} \times 240 - 120 = 75$$

$$\text{And total students in Art in B} = 210 - \frac{2}{7} \times 210 - 40 = 110$$

Stream	A	B
Art	120	110
Science	75	60
Commerce	45	40
Total	240	210

S61. Ans.(d)

$$\text{Sol. Required percentage} = \frac{120-60}{60} \times 100 = 100\%$$

S62. Ans.(a)

$$\text{Sol. Required ratio} = \frac{40}{75} = 8 : 15$$

S63. Ans.(e)

$$\text{Sol. Total students in Art \& Commerce in C} = 180 - 40 \times \frac{125}{100} = 130$$

$$\text{Required difference} = (120 + 45) - 130 = 35$$

S64. Ans.(b)

$$\text{Sol. Required average} = \frac{75+60}{2} = \frac{135}{2}$$

S65. Ans.(c)

Sol. total boys in Art from both sections = $120 \times \frac{5}{8} + 110 \times \frac{7}{11}$
 = 75 + 70 = 145

Solutions (66-70): From the given statements, two persons sit between D and S, who faces to the center. Here we get 2 possibilities i.e. Case 1 and Case 2. Q sits immediate to the right of D. Both R and C are sitting opposite to each other. C sits near to Q.

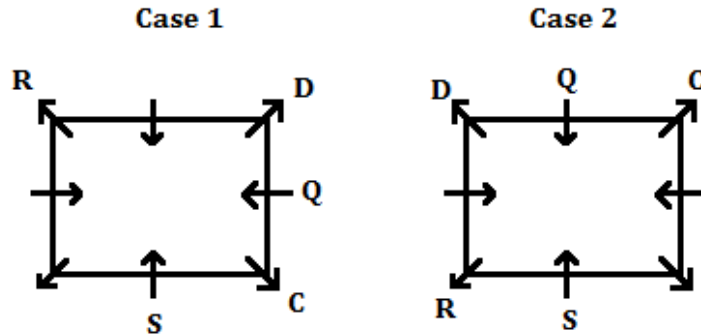

From the given statements, only one person sits between A and B, who does not sit near to D. Here Case 2 is ruled out now.

So, the final arrangement will be like this-

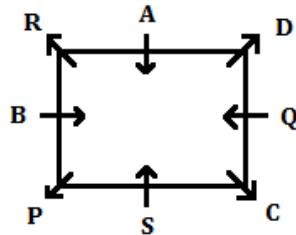

S66. Ans.(a)

S67. Ans.(b)

S68. Ans.(e)

S69. Ans.(d)

S70. Ans.(d)

Solutions (71-73):

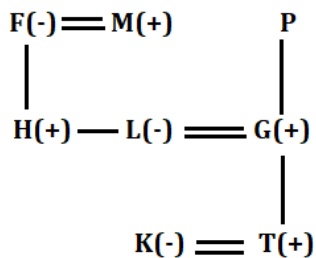

S71. Ans.(c)

S72. Ans.(c)

S73. Ans.(a)

Solutions (74-77):

Words	Codes
work	gi
just	ds
not	nj
done	hq
same	sw
equal	as
opposite	ap
case	kl
but	mn
and	xz

S74. Ans.(a)**S75. Ans.(b)****S76. Ans.(c)****S77. Ans.(c)**

Solutions (78-82): There are more than three students have exam after A. Only one student has exam between A and H. From these conditions we have four possible cases-

	Case- 1	Case- 2	Case- 3	Case- 4
Day	Student	Student	Student	Student
Monday	H			A
Tuesday			A	
Wednesday	A	A		H
Thursday			H	
Friday		H		
Saturday				
Sunday				

G has exam before H but not immediate before H. By this condition case- 1 and case- 4 are cancelled. There are three students have exam between G and B. So new arrangement will be-

	Case- 2	Case- 3
Day	Student	Student
Monday		G
Tuesday	G	A
Wednesday	A	
Thursday		H
Friday	H	B
Saturday	B	
Sunday		

There are three students have exam between D and E, who does not have exam in the last day of week. By this condition case- 2 is cancelled. So final arrangement will be-

Day	Student
Monday	G
Tuesday	A
Wednesday	E
Thursday	H
Friday	B
Saturday	L
Sunday	D

S78. Ans.(c)

S79. Ans.(d)

S80. Ans.(b)

S81. Ans.(a)

S82. Ans.(e)

Solutions (83-85):

S83. Ans.(a)

Sol. I: $R > Y$ (True) **II:** $J < B$ (False)

S84. Ans.(d)

Sol. I: $Z \leq I$ (False) **II:** $O > G$ (False)

S85. Ans.(c)

Sol. I: $E > B$ (False) **II:** $B = E$ (False)

Solutions (86-88):

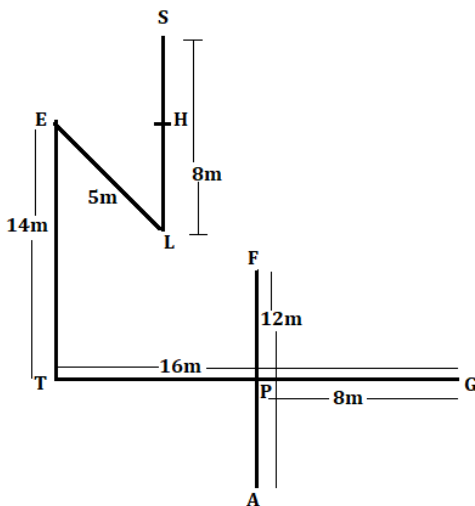

S86. Ans.(d)

S87. Ans.(e)

S88. Ans.(b)

S89. Ans.(e)

Sol.



S90. Ans.(d)

Sol. Words are- D, A, E, R

Meaningful words will be **Dear, Dare, Read.**

Solutions (91-95): From the given statements, there is one person sits between N and M and one of them are sit at the extreme end of the row. There are three persons sit between N and C. L sits 2nd to the left of C. **Here we get 3 possibilities i.e. Case 1 , Case 2 and Case 3.**

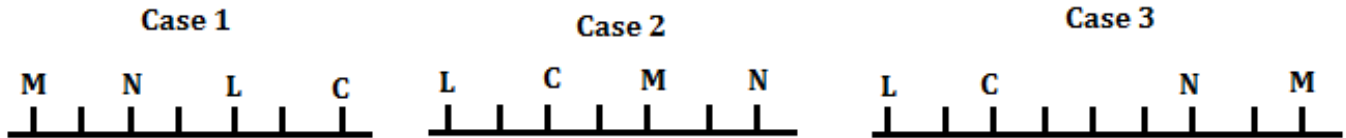

From the given statements, there are six persons sit between C and B, who sits 3rd from one of the end. B sits 2nd to the left of R, who does not sit at the extreme end. **From this condition Case 1 is ruled out now.**



From the given statements, there are four persons sit between O and N. More than three persons sit between M and O. **From this condition Case 2 is ruled out now.** There are two persons sit between K and R.

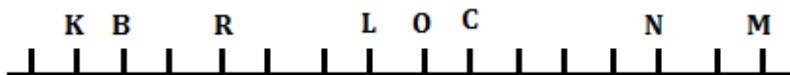

S91. Ans.(e)

S92. Ans.(b)

S93. Ans.(c)

S94. Ans.(b)

S95. Ans.(b)

Sol.

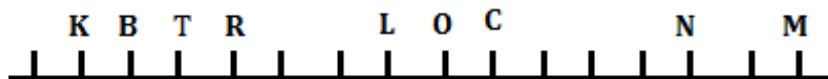

Solutions (96-100): From the given statements, three boxes are placed between M and T. M is placed either at the top most or bottom most position. **Here we get 2 possibilities i.e. Case 1 and Case 2.** Box S is placed just below to the box T. There are two boxes placed between R and S.

Case 1	Case 2
Boxes	Boxes
M	
	R
R	
	T
T	S
S	
	M

From the given statements, not more than two boxes placed between M and R. **Here case 2 is ruled out now.** Box O is placed just above to the box N. More than three boxes placed between O and P.

So, the final arrangement will be like this-

Boxes
M
P
R
Q
T
S
O
N

S96. Ans.(a)

S97. Ans.(d)

S98. Ans.(e)

S99. Ans.(c)

S100. Ans.(e)